

BLASI S16-SU in-ground operated sliding door

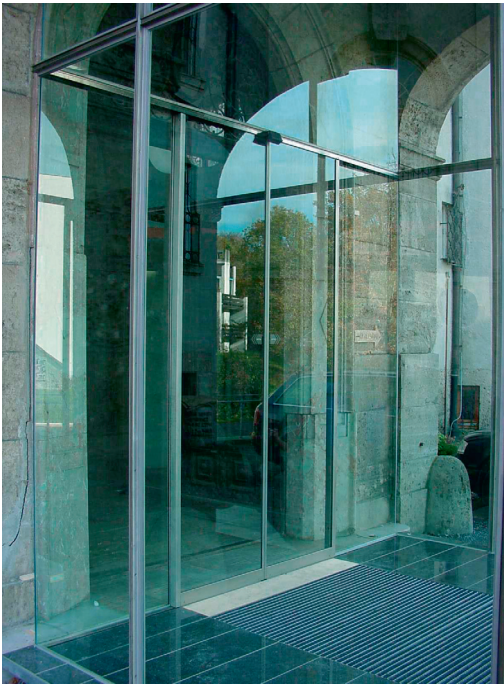

SYSTEM:

The BLASI designed in-ground sliding door is specially made to avoid a bulky header or overhead boxes while the drive unit is totally hidden in the floor. The advantage is evidently to create a perfect build up and transparency while offering a system that can also carry heavy door leaves.

The comfort and use of the S16 SU is exactly the same as every standard overhead sliding door but offers a higher flexibility for the building design and structure and provides a perfect aesthetic solution.

The drive unit is executed with an in-ground stainless steel encasing, a sealed separation for the electronic and the motor components. A specially developed gully trap and drainage outlets will protect the unit and ensure a safe and proper operation for the same lifetime as any other regular overhead sliding door.

The wide range of the S16 SU offers executions as single-slide, bi-part, v-shaped, inclined and even slanted designs that will cover any requirement.

- Sliding door that can be used in any buildings like office buildings, hotels, hospitals, airports, museums, shopping malls, residential buildings and many more
- Perfect solution for any glass façade and curtain wall system
- Frameless option available for incredible transparency
- Silent and reliable drive unit that has been developed specially for in-ground use
- Passage heights up to 5000mm are possible (on request)
- Installation depth of operator only 200mm

BLASI S16-SU in-ground operated sliding door

Passage Opening " A "		
Minimal	850 mm	≈ 3' - 10"
Maximal	4000 mm	≈ 13'
Passage Height " G "		
	5000 mm	≈ 16' - 5"
Drive Unit Length " F "		
	2x "A" + 100 mm (+ 4")	
Door Leaf Weight		
Single slide	max. 200 kg (440 lbs)	
Double slide (bi-part)	max. 400 kg (880 lbs)	

Installation Depth	min. 200 mm (8")
Installation Width	min. 350 mm (14")
Opening Speed	max. 0,7 meter/second
Closing Speed	max. 0,7 meter/second
Please note that the speed needs to be adjusted in accordance to your local codes & requirements	
Installation Height of Top-Guide	
Minimal	55 mm (≈ 2 - 1/4")

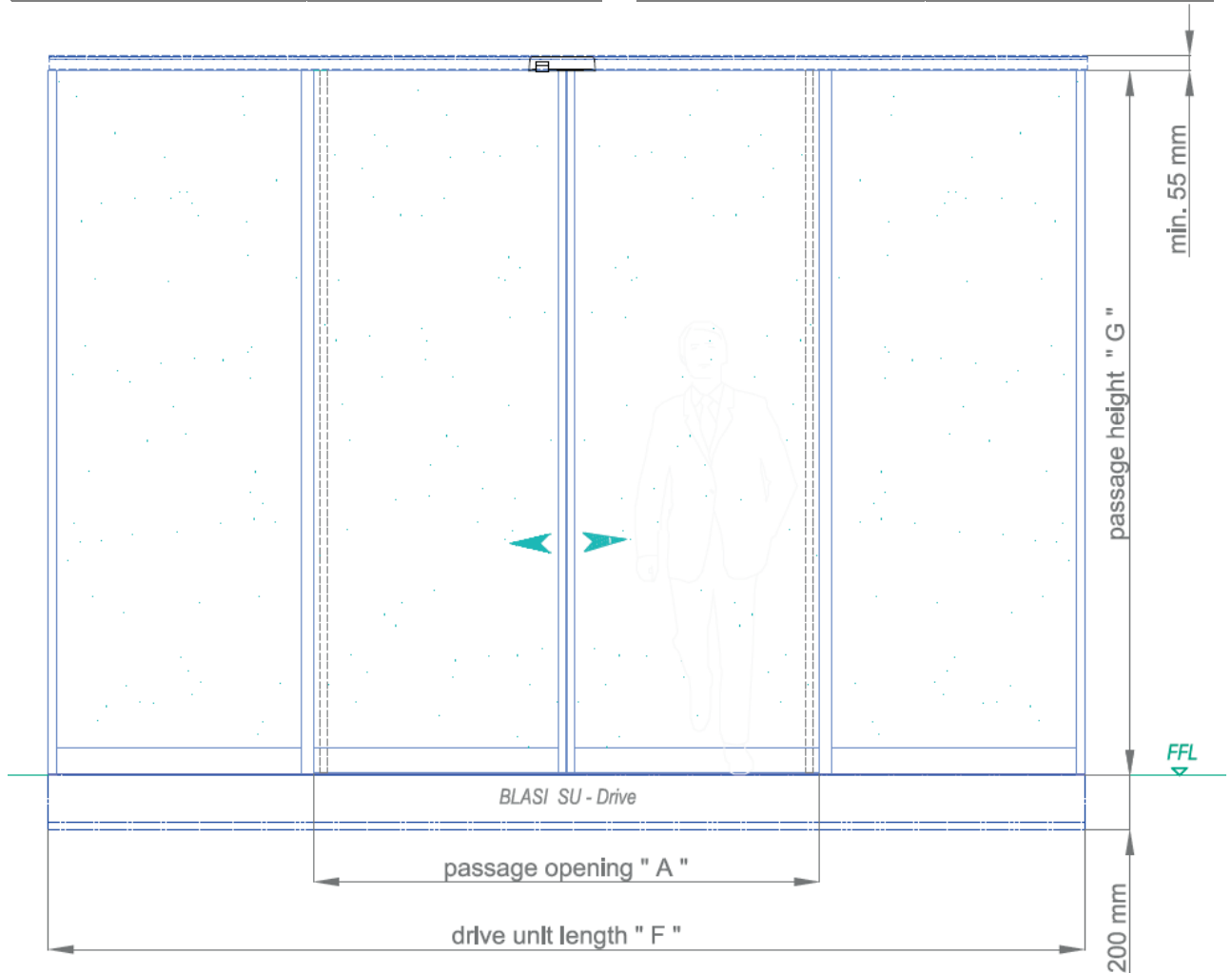

BLASI S16-SU in-ground operated sliding door

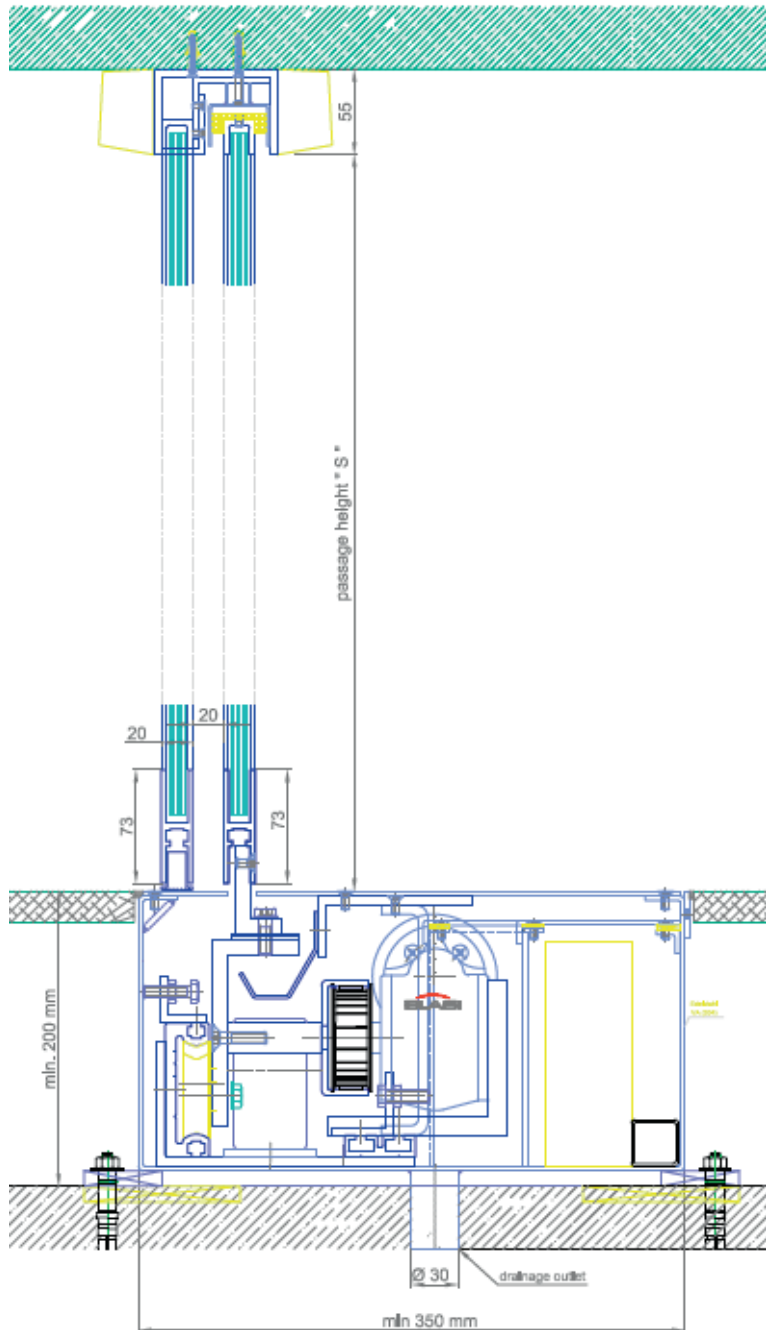

Vertical section:

Example shows how the top-guide can be fixed to a ceiling slab; encasing in aluminium (optional in stainless steel and any other quality surface)

The complete load of the door leaf is distributed on the bottom track; the top track absorbs only vertical loads such as wind-force

Bottom drive unit installed below finished floor; thresholds cover plates and encasing in standard stainless steel 304

NOTE:

Drainage outlet required to drain water out of the bottom track (necessary for all in-ground systems)

BLASI S16-SU in-ground operated sliding door

DESIGN FEATURES:

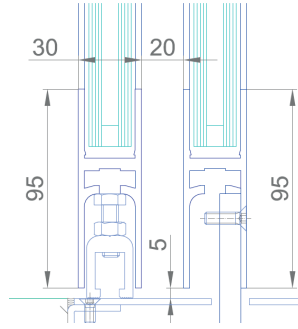
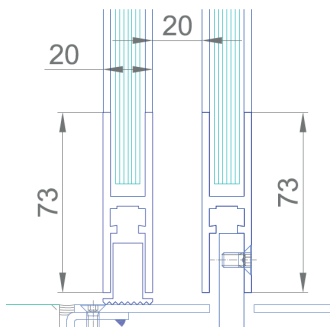

- Single glass profile in 20mm wide and 73mm high aluminium extrusion
- Double glass profile in 30mm wide and 95mm high aluminium extrusion
- Wet glazing (silicone) that provides high durability

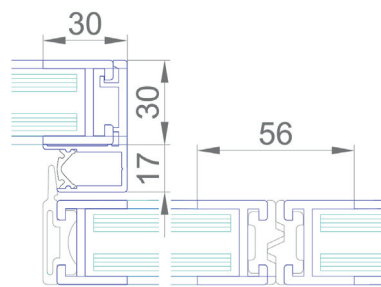
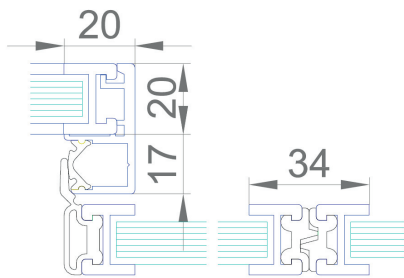

- Single glass profiles in slim 20 x 20mm profile design including a high durable neoprene sealant
- Double glazed aluminium profiles with 30 x 30mm for the use of glass up to 20mm

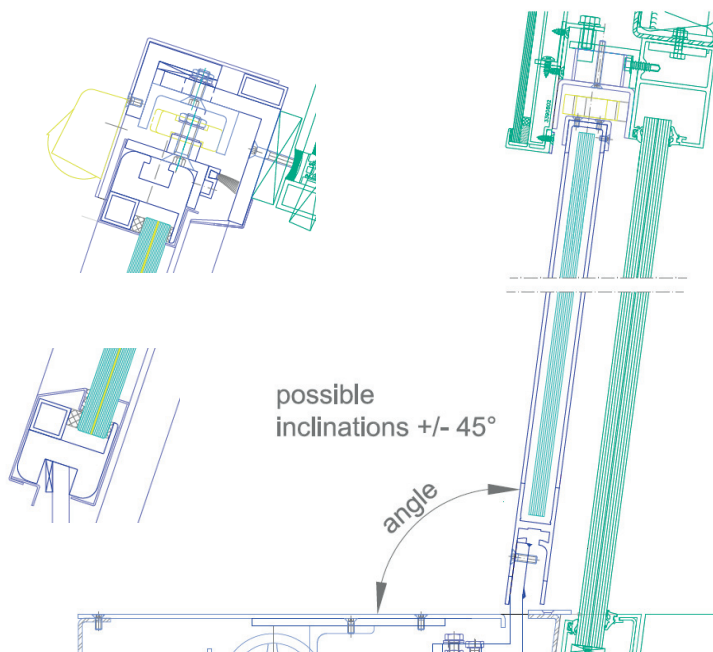

- Inclined executions for door leaves and side screens possible in various designs
- Individual special profiles for the use and implementation of different glasses possible on request
- Also rhombus (slanted) design executions are possible; in combination with inclined door leaves will that provide a new horizon for your building

BLASI S16-SU in-ground operated sliding door

BASIC EQUIPMENT:

The door is supplied including the following basic parts and features:

1 no. Operating switch with following modes:
(OFF– Automatic – One Way – Hold Open)

1 no. Emergency Stop Switch

OPTIONAL:

1 no. Digital status and error display

Including all necessary safety features as required by latest standards.

SURFACE:

The surface can be provided in any standard RAL powder coating or standard anodizing where BLASI provides and uses the highest quality. Stainless steel clad surface in quality 304 or 316, bronze or brass are also possible on a totally bespoke (tailor) execution.

BASIC OPTIONS:

- Potential free monitoring contacts (NO) for status control of the electromechanical lock or for the position of the door leaves
- Summer and winter mode switch that allows the user to choose for a reduced opening width that helps during the cold season
- Emergency escape package including a special designed fail-safe operator that will open the door leaves in case of a failure or in the event of a fire- or smoke alarm is triggered (this redundant escape package is not available for break-out door leaves)
- Special stainless steel tray that will allow implementing the finish floor directly over the drive unit. This improves the design as the threshold cover plate is hidden
- Single slide in left or right hand execution as standard available in many variations
- Electromechanical locking including a special unlocking device to secure your building

GLAZING:

Door leaves and side screens can be executed in special slim BLASI aluminum extrusions with a size of only 73 x 20 x 20mm (height x width x length) where a glass thickness of max. 10mm can be glazed. Typically a single sheet tempered safety glass with 10mm is used.

Double glazed insulating glass with a maximum thickness of 20mm will be framed in the BLASI profiles with a size of 95 x 30 x 30mm (height x width x length).

Special profiles and executions can also be provided optionally for custom glazing such as triple glazing, bullet- or blast resistant glasses or panel door leaves.

DESIGN OPTIONS:

- Low iron glass (white-glass); tinted glass and special glasses on request
- Mid-rails (muntin) at drum walls or rotating centerpiece, impact protection from trolleys
- Vertically rhombus (slanted) door leaf executions are also available; possible as well in combination with inclination

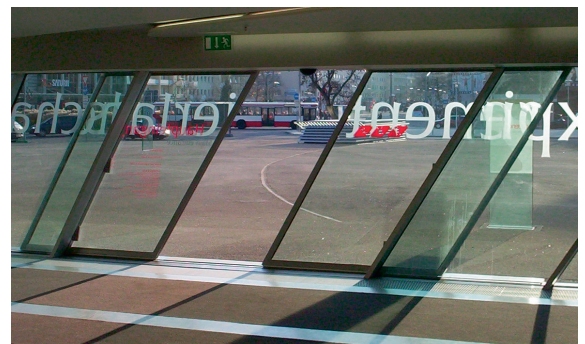

- Individual design executions in a wide range possible on request
- Full glass design where even the bottom profile can be implemented (hidden) within the drive unit to ensure total glass view

BLASI S16-SU in-ground operated sliding door

TECHNICAL DATA:

Power supply 230V AC or 120 V AC, 50 - 60Hz
Power connection single phase alternative current, fused 16 Ampere
Power consumption maximum 250 Watt

Control Unit 24V DC (short-circuit-proof)
Motor Current 48V DC (pulsed)

- all cables and conduits to be supplied by others (as per wiring diagram by Blasi)
- optionally monitoring contacts for status of lock and door position (potential free, NO)
- optionally monitoring contacts for door interruptions and status (potential free, NO)

ENVIRONMENTAL CONDITIONS:

Temperature Range -15°C (45°F) up to + 50°C (105°F)
Humidity Range up to 85% relative humidity
Case Protection IP 54 (for protected internal use)

CONTACT:

BLASI GmbH
Automatic Door Systems
Carl-Benz-Str. 5 – 15
77972 Mahlberg / Germany

P.: +49 7822 893-160
F.: +49 7822 893-169

Email: sales@blasi.info
Web: www.blasi.info

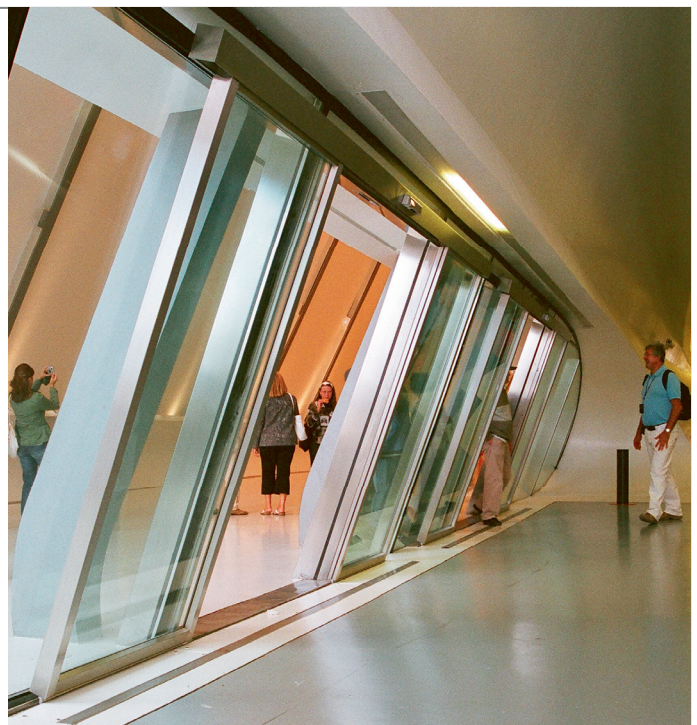

NOTE: Blasi reserves the right for technical or content alterations without pre-notification at any time.